

REV.	ECN NO.	LOCAS.	DESCRIPTION	DATE	DESIGN
A			NEW DRAWING	22.12.01	Jenply

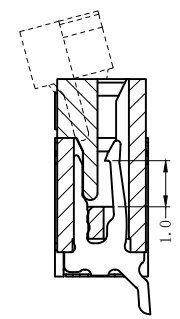

SECTION A-A

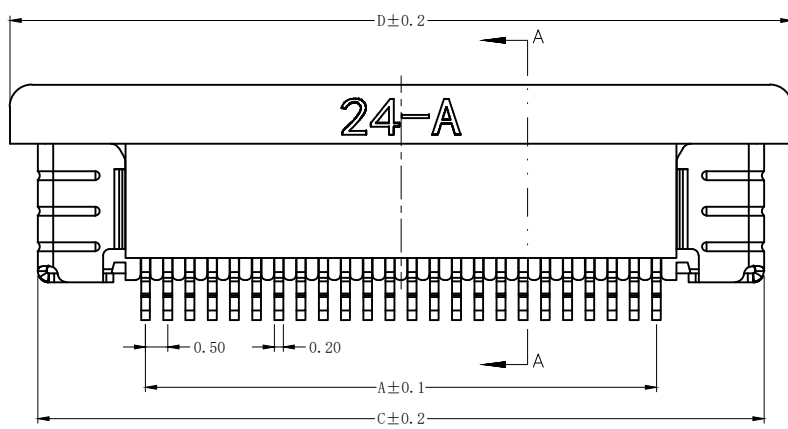
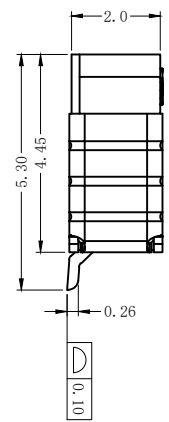
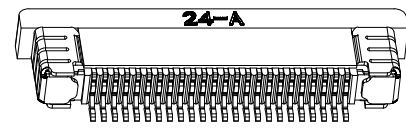
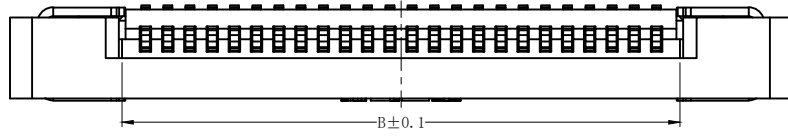
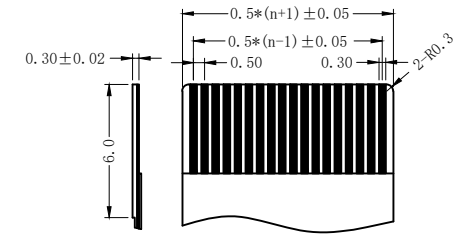
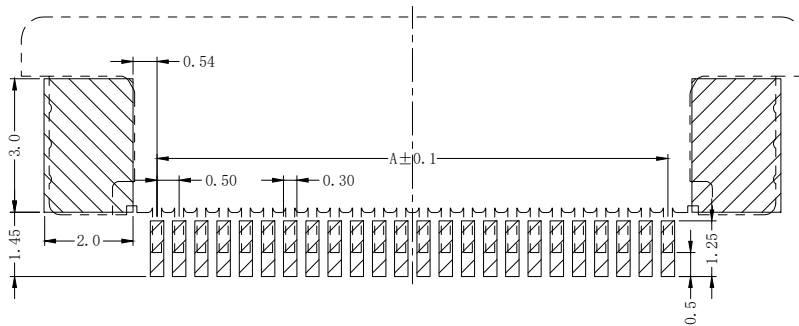

PROPER CABLE (SCALE 2:1)

孔位	A	B	C	D
4	1.50	2.60	6.35	7.65
5	2.00	3.10	6.85	8.15
6	2.50	3.60	7.35	8.65
7	3.00	4.10	7.85	9.15
8	3.50	4.60	8.35	9.65
9	4.00	5.10	8.85	10.15
10	4.50	5.60	9.35	10.65
11	5.00	6.10	9.85	11.15
12	5.50	6.60	10.35	11.65
13	6.00	7.10	10.85	12.15
14	6.50	7.60	11.35	12.65
15	7.00	8.10	11.85	13.15
16	7.50	8.60	12.35	13.65
17	8.00	9.10	12.85	14.15
18	8.50	9.60	13.35	14.65
19	9.00	10.10	13.85	15.15
20	9.50	10.60	14.35	15.65
21	10.00	11.10	14.85	16.15
22	10.50	11.60	15.35	16.65
23	11.00	12.10	15.85	17.15
24	11.50	12.60	16.35	17.65
25	12.00	13.10	16.85	18.15
26	12.50	13.60	17.35	18.65
27	13.00	14.10	17.85	19.15
28	13.50	14.60	18.35	19.65
29	14.00	15.10	18.85	20.15
30	14.50	15.60	19.35	20.65
31	15.00	16.10	19.85	21.15
32	15.50	16.60	20.35	21.65
33	16.00	17.10	20.85	22.15
34	16.50	17.60	21.35	22.65
35	17.00	18.10	21.85	23.15
36	17.50	18.60	22.35	23.65
37	18.00	19.10	22.85	24.15
38	18.50	19.60	23.35	24.65
39	19.00	20.10	23.85	25.15
40	19.50	20.60	24.35	25.65
41	20.00	21.10	24.85	26.15
42	20.50	21.60	25.35	26.65
43	21.00	22.10	25.85	27.15
44	21.50	22.60	26.35	27.65
45	22.00	23.10	26.85	28.15
46	22.50	23.60	27.35	28.65
47	23.00	24.10	27.85	29.15
48	23.50	24.60	28.35	29.65
49	24.00	25.10	28.85	30.15
50	24.50	25.60	29.35	30.65
51	25.00	26.10	29.85	31.15
52	25.50	26.60	30.35	31.65
53	26.00	27.10	30.85	32.15
54	26.50	27.60	31.35	32.65
55	27.00	28.10	31.85	33.15
56	27.50	28.60	32.35	33.65
57	28.00	29.10	32.85	34.15
58	28.50	29.60	33.35	34.65
59	29.00	30.10	33.85	35.15
60	29.50	30.60	34.35	35.65

技术要求 (Technical Index):

PC BOARD LAYOUT

1. 材质与表面处理 (Material And Finish):
 基座 (Housing) and 盖子 (Cover): LCP UL94V-0 Nature Or Black;
 端子 (Terminal): Phosphor Copper Au/Sn Plated;
 焊片 (Solder): Copper Alloy Au/Sn Plated;
2. 工作温度 (Temperature range): -25° C ~ +85° C.
3. 额定电压 (Rated voltage): 50V, AC/DC.
4. 额定电流: 0.4A, AC/DC.
5. 接触电阻 (Contact resistance): ≤ 20mΩ.
6. 绝缘电阻 (Insulation resistance): ≥ 500MΩ.
7. 耐电压 (Withstanding Voltage): 200V AC/minute.

DESIGN:	Jenply			QWYCONN® 深圳市启崴源电子有限公司 SHENZHEN QIWEIYUAN ELECTRONIC CO., LTD.	
CHECK:	Ke Tian				
APPROVED:	Youquan Xu			TITLE: 0.5mm FPC (A型) 下接	
DIM	TOL	DIM	TOL	PART NO. 0.5K-AX-nPWB-***	
X.	±0.25	X°.	±3.0°	REV. A	SCALE: N/A
X.X	±0.20	X.X°			
X.XX	±0.15	X.XX°			
X.XXX		X.XXX°			
				UNIT: mm	SHEET: 1/1