

RoHS

PITCH 1.0mm FPC CONNECTOR SMT TYPE

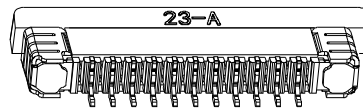
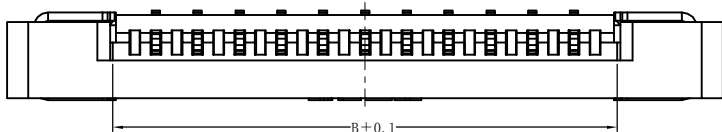

性能:

额定电流: 0.4A
 额定电压: 50V
 耐电压: 200V
 接触电阻: $\leq 20m\Omega$
 绝缘电阻: $\geq 500M\Omega$
 工作温度: $-20^{\circ}C \sim +85^{\circ}C$

塑件 (材质): LCP, UL94V-0
 锁扣 (材质): LCP, UL94V-0
 插簧 (材质): 磷青铜, 镀锡/镀金
 焊片 (材质): 磷青铜, 镀锡/镀金

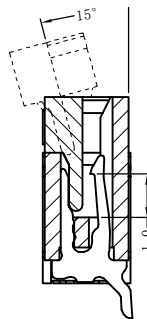
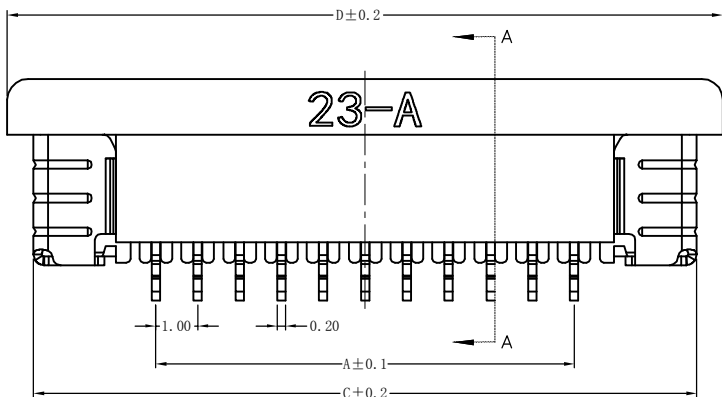
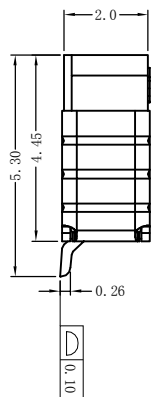

SECTION A-A

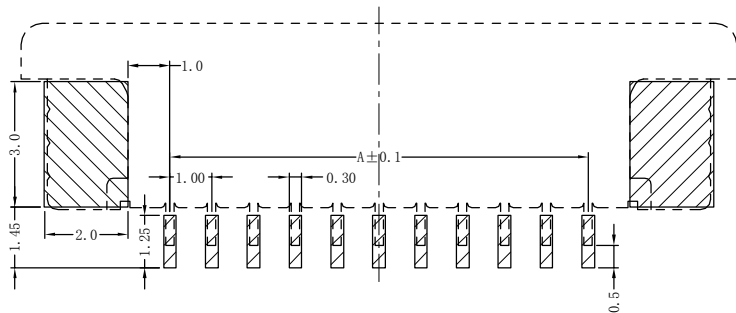

PC BOARD LAYOUT

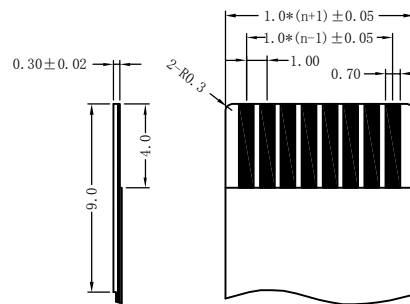

PROPER CABLE (SCALE 2:1)

| 孔位 | A | B | C | D |
|----|-------|-------|-------|-------|
| 2 | 1.00 | 3.10 | 6.85 | 8.15 |
| 3 | 2.00 | 4.10 | 7.85 | 9.15 |
| 4 | 3.00 | 5.10 | 8.85 | 10.15 |
| 5 | 4.00 | 6.10 | 9.85 | 11.15 |
| 6 | 5.00 | 7.10 | 10.85 | 12.15 |
| 7 | 6.00 | 8.10 | 11.85 | 13.15 |
| 8 | 7.00 | 9.10 | 12.85 | 14.15 |
| 9 | 8.00 | 10.10 | 13.85 | 15.15 |
| 10 | 9.00 | 11.10 | 14.85 | 16.15 |
| 11 | 10.00 | 12.10 | 15.85 | 17.15 |
| 12 | 11.00 | 13.10 | 16.85 | 18.15 |
| 13 | 12.00 | 14.10 | 17.85 | 19.15 |
| 14 | 13.00 | 15.10 | 18.85 | 20.15 |
| 15 | 14.00 | 16.10 | 19.85 | 21.15 |
| 16 | 15.00 | 17.10 | 20.85 | 22.15 |
| 17 | 16.00 | 18.10 | 21.85 | 23.15 |
| 18 | 17.00 | 19.10 | 22.85 | 24.15 |
| 19 | 18.00 | 20.10 | 23.85 | 25.15 |
| 20 | 19.00 | 21.10 | 24.85 | 26.15 |
| 21 | 20.00 | 22.10 | 25.85 | 27.15 |
| 22 | 21.00 | 23.10 | 26.85 | 28.15 |
| 23 | 22.00 | 24.10 | 27.85 | 29.15 |
| 24 | 23.00 | 25.10 | 28.85 | 30.15 |
| 25 | 24.00 | 26.10 | 29.85 | 31.15 |
| 26 | 25.00 | 27.10 | 30.85 | 32.15 |
| 27 | 26.00 | 28.10 | 31.85 | 33.15 |
| 28 | 27.00 | 29.10 | 32.85 | 34.15 |
| 29 | 28.00 | 30.10 | 33.85 | 35.15 |
| 30 | 29.00 | 31.10 | 34.85 | 36.15 |

UNITS
mm

MAT'L

FINISH

Q'TY

PCS

QWYCONN® 深圳市启崴源电子有限公司
 SHENZHEN QIWEIYUAN ELECTRONIC CO., LTD.

PART NO.(INTENDED USE)

1.0K-MX-nPWB

TITLE:

1.0mm FPC (A型) 下接(H=2.0)

APPD:

DWG NO.:

100K04-AXB0000000

CHKD:

DR: HU 2016.09.28

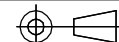

SCALE

1/1

SHEET

1/1

REV.

A